

May - June, 2024

LONDON

Discover central London, with its iconic landmarks, world-class entertainment, hidden gems, and innovative pop-up experiences.



Brought to you by

CENTRAL LONDON ALLIANCE

In partnership with





BLUE ORCHID
HOSPITALITY



Family Fun In London

MAY BANK HOLIDAY

with iconic London landmarks right at your doorstep

Unrivalled views



Stunning views over
the Tower Bridge and
Tower of London

Independent Living



Offering independent
living with private
kitchens and lounges

Myriad Facilities



Onsite restaurants,
bars, spas, gyms,
co-working spaces

www.blueorchid.com

Directors' note

The capital awakens with a renewed energy, offering an array of captivating experiences throughout May and June. Discover alfresco dining spots, bustling markets and carefully curated exhibitions against the background of the city's iconic landmarks and picturesque parks.

Whether you live, work, study in or visit London, Central London Alliance's *What's On in London* Magazine is your indispensable guide to making the most of your time in this dynamic metropolis. Join us as we celebrate the spirit of London and embrace the endless possibilities that await.

We hope you that you will find inspiration, and countless reasons to fall in love with this remarkable city all over again.



Tony Matharu
Founder and Chairman
Central London Alliance C.I.C
Integrity International Group



Nadia Perrier
Director
Central London Alliance C.I.C



Richard Burge
Director
Central London Alliance C.I.C



TABLE OF CONTENTS

WHAT'S ON IN MAY AND JUNE

5	<i>Events in May</i>
7	<i>ExCel Events</i>
10	<i>Events in June</i>
13	<i>Exhibitions</i>
15	<i>Theatres</i>
17	<i>Family Events</i>
19	<i>The City of London events</i>

London welcomes the arrival of May with a plethora of new events. Stunning outdoor spaces finally come alive: from centuries-old traditions to contemporary celebrations, May in London promises an experience that is as diverse as it is captivating.



MAY

LONDON EVENTS



WWW.BETWEENTHEBRIDGES.CO.UK

BETWEEN THE BRIDGES

This seasonal pop-up between Waterloo and Westminster bridges offers a renowned selection of London's finest street food and drinks, along with an eclectic programme of free and ticketed events across drag shows, themed club nights, DJs and live performances.
2 May to 12 July
The Queen's Walk, Southbank, SE1



WWW.BUSINESSDESIGNCENTRE.CO.UK

SICILYFEST

Four days to enjoy the tantalising array of stalls which will mainly focus on Sicilian food produce, wine and drinks. Have a taste of what it feels like to walk down a Sicilian street market.
2 to 5 May
Business Design Centre, 52 Upper Street, N1 0QH



WWW.EUROSMAH.CO.UK

EUROSMAH FESTIVAL

A huge Eurovision fans gathering, that also features comedy, games, food stalls and merchandise pop-ups. See your favourite Eurovision icons live and immerse in a diverse world of pop-music.
Saturday 4 May
Woolwich Works, The Fireworks Factory, SE18 6HD



WWW.GLITTERFEST.ORG

GLITTERFEST

It's an evening to let your glitter and gems, metallics, sequins, and tassels shine. The sparkiest party in the world includes dancing, pyro, confetti cannons, performers, stilt walkers + DJs playing the best in RNB, Hip Hop, Bashment & UKG.
Saturday 4 May
Between The Bridges, Southbank, SE1 8XX



WWW.DECORATIVEFAIR.COM

THE DECORATIVE FAIR

A unique and inspiring collection of antiques and designs from a wide range of dealers. You can get some affordable and exclusive pieces, as well as lots of inspiration.
Tuesday 7 May
Evolution London, Battersea Park, SW11 4NJ



WWW.NATIONALGALLERY.ORG.UK

NATIONAL GALLERY'S BICENTENARY

National Gallery celebrates 200 years of bringing people and paintings together. A year-long festival of art, creativity and imagination starts in May and sets the tone for their third century.
From 10 May
Trafalgar Square, WC2N 5DN



WWW.INDEPENDENTLABELMARKET.COM

INDEPENDENT LABEL MARKET

While the music industry becomes more and more digitalised, this event is proving to be a valuable reminder of how music retail can be a social affair; people hanging out together as a community and buying records.
Sunday 11 May
Coal Drops Yard, King's Cross, N1C 4DQ

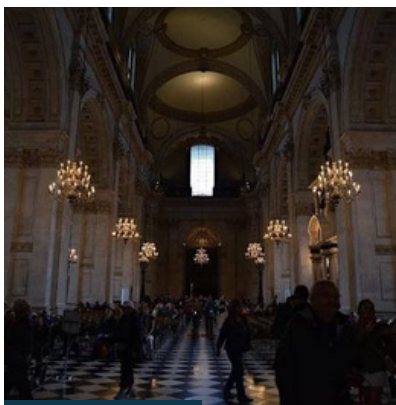

WWW.STPAULS.CO.UK

ST PAUL'S CATHEDRAL AT NIGHT

Explore the little known stories of the Cathedral's rich history with guided tours and trails, join handling sessions with expert craftspeople, and enjoy the Cathedral's art including works by Henry Moore and Bill Viola.
Starts 11 May
St Paul's Cathedral, EC4M 8AD



WWW.LONDONCRAFTWEEK.COM

LONDON CRAFT WEEK

Celebrating outstanding British and international makers, the festival brings together over 750 established and emerging crafters, designers, brands and galleries with an array of events in all parts of London. A curated selection based not on price or fame, but underlying substance.
13 to 19 May
Across London



WWW.CLERKENWELLDISIGNWEEK.COM

CLERKENWELL DESIGN WEEK

Clerkenwell is one of the most important design hubs in the world. That's what the design week celebrates, featuring 600+ showroom events, 11+ curated exhibitions, striking installations, topical talks, a fringe programme, food and drink partners and more.

Sunday 14 May
Across Clerkenwell



WWW.LAITHWAITES.CO.UK

LAITHWAITES WINE FESTIVAL

An entire world of wine to enjoy at one of London's most impressive venues. Taste over 350 wines – all included in the ticket price!

17 and 18 May
Kensington Olympia, W14 8UX



WWW.EUROPEANWRITERS.CO.UK

EUROPEAN WRITERS' FESTIVAL

Thirty writers, each representing one European country or territory, come together at the British Library for a full weekend celebration of the best European writing. The 2024 theme is 'Transformation'

18 and 19 May
The British Library, NW1 2DB



WWW.LYMPHOMA-ACTION.ORG.UK/BRIDGESWALK

BRIDGES WALKS 2024

Join inclusive Bridges Walks, where everyone can participate and contribute to raising funds and awareness for those impacted by lymphoma.

7-mile route crosses London's most iconic bridges from Vauxhall to Tower Bridge.

Sunday 19 May
Starts from Vauxhall Bridge



WWW.GREENWICHPENINSULA.CO.UK

URBAN VILLAGE FETE

Greenwich Peninsula's Urban Village Fete is back, and it's bigger than ever. Enjoy the best street food London has to offer, spot the legendary DJs, participate in interactive workshops, creative talks and speaker sessions.

Sunday 19 May
Greenwich Peninsula, SE10 0BN

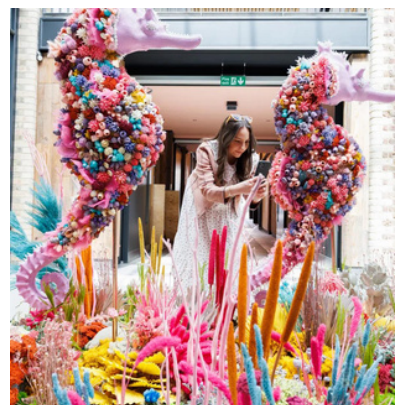

WWW.BELGRAVALDN.COM

BELGRAVIA IN BLOOM FESTIVAL

Get your fill of fabulous florals at the free festival, this year's theme is Floral Fun and Games.

Explore eye-popping floral displays and unique experiences across the Belgravia neighbourhood.

20 to 27 May
Across Belgravia



WWW.RHS.ORG.UK

RHS CHELSEA FLOWER SHOW

RHS Shows represent the pinnacle of horticultural excellence, and there's something for everyone no matter what kind of gardener you are.

21 to 25 May
London Gate, Royal Hospital Road, SW3 4SR



WWW.BLUEORCHID.COM

THE WELLINGTON HOTEL BY BLUE ORCHID HOSPITALITY

The Wellington is nestled in a tranquil Westminster enclave on leafy Vincent Square, combining traditional elegance with contemporary style and modern decor. Located 50 metres from The Royal Horticultural Society and The Royal Horticultural Halls, this hotel is ideal for the Chelsea Flower Show.

71 Vincent Square, SW1P 2PA



Jed Leicester for London Marathon Events

WWW.RIDELONDON.CO.UK

RIDE LONDON FREecycle

Cycle through the best traffic-free central London locations.

The whole route starts and ends on the corner of Green Park and St James's Park, though anyone is welcome to join at any point during the ride.

Sunday 26 May
Across Central London

MAY - JUNE 2024
Royal Victoria Dock,
E16 1XL

Excel events

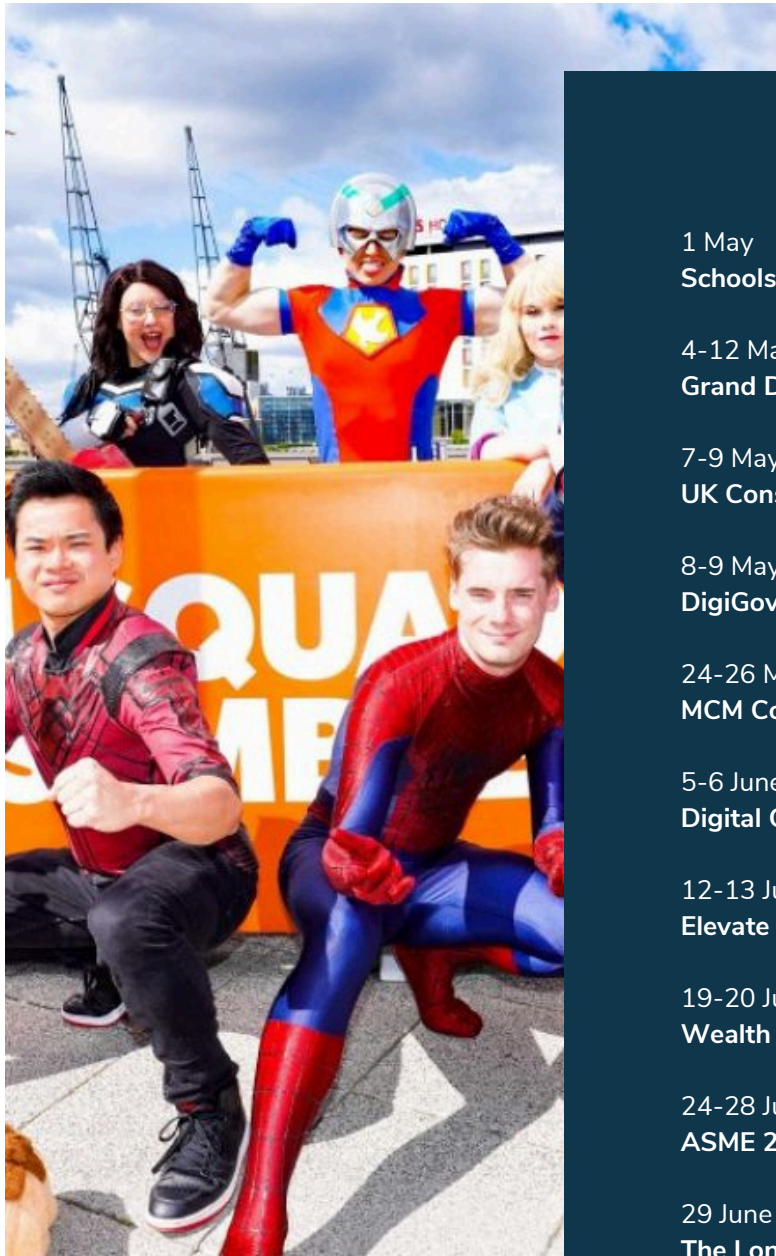

1 May
Schools & Academies Show

4-12 May
Grand Designs Live London

7-9 May
UK Construction Week London

8-9 May
DigiGov Expo

24-26 May
MCM Comic Con

5-6 June
Digital Construction Week

12-13 June
Elevate

19-20 June
Wealth Transformation Summit

24-28 June
ASME 2024 Turbo Expo

29 June
The London Tattoo



WWW.EXCEL.LONDON



HOW CAN BUSINESSES UTILISE SPORT TO ENHANCE THEIR WORKFORCE?

In today's fast-paced working world, prioritising employee health and wellbeing has become more critical than ever for organisations looking to attract and retain the best talent for their business. One of the most effective ways to achieve this is by introducing sporting initiatives and events to the workplace and culture.

Encouraging physical activity brings with it a myriad of benefits: from boosting overall health and wellbeing of employees to enhancing productivity and engagement, fostering inclusivity, reducing absenteeism, and creating a positive working environment.

What's more, playing a sport requires quick decision making and utilising resources as effectively as possible; all transferable skills to the work place. It is critical that workers know how to make effective decisions if they want to succeed in the business world.

Managers will be more effective at their jobs when they know how to act decisively in high-stress situations.

Those playing sports have shown higher levels in communication and collaboration together with judgement skills and improved decision making. Here are some ideas for employers looking to help their workforce to stay active, healthy and productive:

Access to Active Spaces

Consider transforming under-utilised areas into designated exercise zones or wellness rooms, equipped with exercise equipment, yoga mats, or even movable walls that allow for larger breakout space if needed, which can be used during lunch hours or after work.

If space allows, consider rooftop or underground areas for unique, inclusive sports such as padel. Examples of creativity can be taken from a market leader, Stratford Padel Club, who transformed a car park into one of London's most popular community padel clubs.

An active space can be an affordable solution that entices professionals and helps to retain current talent.



Private Team Sessions

There are many sporting activities and venues in the city available for private sessions and team building.

Blue Orchid Hospitality offer public and private Rooftop Yoga + Breakfast sessions. The breath-taking setting of The Skyline London's rooftop provides the ideal back drop, and can be utilised for private hire.

Stratford Padel Club offers corporate days out at their club, including coaching sessions with some of the best coaches in the industry, plenty of friendly competition amongst team members through round robin or Americano style tournaments as well as match play, together with food and drinks served for all to enjoy, from paella and tapas to Mexican dishes.

Sports that Foster Inclusivity

Padel is one excellent example of a sport that allows for men and women to seamlessly play alongside one another (30% of registered padel players are women compared to just 15% in tennis).

It's enjoyed by all ages, gender and skill levels. It is one of the few sports that does not rank depending on gender; all scores are irrespective of gender.

Stratford Padel Club (SPC) host an annual mixed tournament that is much loved by their players. One member of SPC commented: "It is easy and fun to play mixed matches. Our mixed tournament is the busiest in the club, that is a proof that everyone enjoys it." Using sports to foster inclusivity is a powerful tool for bringing people together!

"It is easy and fun to play mixed matches. The mixed tournament is a proof that everyone enjoys it, as it is the busiest tournament in the club."

Sporting Challenges and Events

Sporting challenges and events are excellent initiatives to engage employees, network and strengthen professional relationships. These initiatives foster team building, boost morale, and create a sense of camaraderie among employees, in turn leading to better job satisfaction among staff members.

Consider signing up various departments (encouraging cross-departmental participation) in your organisation in sporting challenges, fitness contests, or team sports activities. Keep an eye out for what's to come this summer from CLA and its partners, following the success of the Padel Tennis Festival last year.

Sponsorship Opportunities

Consider sponsorship opportunities of initiatives that enhance brand visibility and employee motivation. Aligning yourself with health and wellbeing initiatives is only going to add to brand perception values, and will give your employees plenty of chances to engage with the sporting activation.

By implementing sporting initiatives, businesses can create an environment that encourages and supports health and wellbeing through physical activity, often leading to greater business success.

To discuss any of the items in this article, speak to CLA at hello@centrallondonalliance.com

Spending the summer in London can bring you memories that will last a lifetime. From sizzling street food festivals to enchanting outdoor concerts, June can be just amazing. Experience the best of London's scene with our guide.



JUNE

LONDON EVENTS



WWW.LONDONGALLERYWEEKEND.ART

LONDON GALLERY WEEKEND

Over 150 of London's leading contemporary galleries will come together for London Gallery Weekend, offering special events, late night openings & more. Navigate London Gallery Weekend via a series of curated routes by world leading art figures.

1 and 2 June
Across London



WWW.LONDONGARDENSTRUST.ORG

LONDON SQUARE OPEN GARDENS

Over one summer weekend, have access to over 100 hidden green spaces not normally open to the public. You'll be able to check out the gardens of Downing Street, Belgrave Square, the Royal College of Physicians Medicinal Garden, and many more.

8 and 9 June
Across West and Central London



WWW.WWW.GREATEXHIBITIONROADFESTIVAL.CO.UK

GREAT EXHIBITION ROAD FESTIVAL

Explore the extraordinary with a weekend of free events for all ages, led by Imperial College London. A selection of free events for all ages, from street art, to the AI Silent Disco, creative hands-on workshops, and incredible performances on the Main Stage.

15 to 16 June
Exhibition Road, South Kensington, SW7 2AZ



WWW.MIGHTYHOOPLA.COM

MIGHTY HOOPLA

Bright and loud, this outdoor festival promises to be pure fun.

This year's line-up features pop sensation Rita Ora and the iconic Nelly Furtado.

1 and 2 June
Brockwell Park, SE24 0NG



WWW.LONDONTechWEEK.COM

LONDON TECH WEEK

Innovators, investors, and tech giants will all gather together for the new tech to solve world's biggest problems.

With over 90 countries represented, this is where the global tech ecosystem intersects with the investment, innovation and talent which calls the UK home.

10 to 14 June
Kensington Olympia, W14 8UX



WWW.SOUTHBANKCENTRE.CO.UK

CHAKA KHAN'S MELTDOWN

The iconic musician curates the 29th edition of *Meltdown*, the UK's longest-running artist-curated music festival.

Other performers are Todrick Hall and the Guildhall Orchestra with more names on the programme to be announced.

14 to 23 June
Southbank Centre, Belvedere Rd, SE1 8XX



WWW.ROUNDHOUSE.ORG.UK

THE LAST WORD FESTIVAL

With an impressive lineup of the UK's most essential voices, this festival promises over two weeks of captivating stories from a wide range of backgrounds and perspectives. Experience the power of the spoken word, engaging conversations and soul-stirring music.

6 to 30 June
Roundhouse, Chalk Farm Rd, NW1 8EH



WWW.LONDON.TASTE.FESTIVALS.COM

TASTE OF LONDON

Every summer Regent's Park is taken over for 5 days by a next level food-fuelled garden party. 55,000 Londoners usually join to devour the taste of the city.

12 to 16 June
The Regent's Park, NW1



WWW.CHANGING-GUARD.COM

TROOPING THE COLOUR: THE KING'S BIRTHDAY PARADE

His Majesty's actual birthday is in November, but traditionally celebrated in summer, at Horse Guards Parade.

You can watch this beautiful royal event along the Mall or from the edge of St James's Park for free.

15 June
Begins at Buckingham Palace



WWW.RAINDANCE.ORG/FESTIVAL

RAINDANCE FILM FESTIVAL

The largest independent film festival in the UK. Experience the world-renowned programme of the best movies and attend engaging networking talks.

19 to 28 June
Across West End



WWW.WEMBLEYSTADIUM.COM

TAYLOR SWIFT, THE ERAS TOUR

A sensational Taylor Swift tour comes to London's Wembley Stadium this summer. See the legendary multiple Grammy winner and enjoy the unbelievable atmosphere, singing together with hundreds of thousands of fans.

21, 22 & 23 June
Wembley Stadium, HA9 0WS



WWW.BLUEORCHID.COM

TOWER SUITES BY BLUE ORCHID HOSPITALITY

Commanding sweeping views over Tower Bridge and the Tower of London, Tower Suites offers independent living inside elegant suites with fully equipped kitchens and lounges, whilst having access to the myriad facilities and services of a luxury hotel in London.

100 Minories, EC3N 1JY



WWW.WEMBLEYSTADIUM.COM

UEFA CHAMPIONS LEAGUE FINAL

The best of the best will be crowned on the ultimate stage when the 2023/24 UEFA Champions League season concludes. Don't miss how the highlight of European football's calendar returns to Wembley Stadium.

Saturday 1 June
Wembley Stadium, HA9 0WS



WWW.KEWFETE.ORG

KEW FETE

A traditional Victorian fun fair offers over 100 stalls, Reuben Bond's Vintage Fairground, together with entertainment on the stage all day. And most importantly, raises funds for 14 local charities like Richmond Food Bank and the Riverbank Trust.

Saturday 22 June
Pond Side, Kew Green, Kew, TW9 3AP

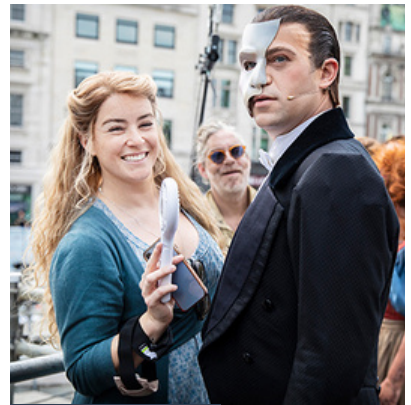

WWW.WESTENDLIVE.CO.UK

WEST END LIVE 2024

Enjoy performances from London's most celebrated West End musicals and exciting new shows, live and absolutely free. West End LIVE is presented by Westminster City Council and the Society of London Theatre with support from the Mayor of London.

22 and 23 June
Trafalgar Square, WC2N 5DS

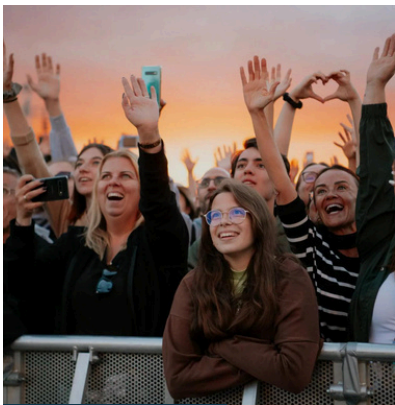

WWW.BST-HYDEPARK.COM

BST HYDE PARK

Last year's hit summer location is about to return! The 2024 line-up includes performers like SZA, Robbie Williams and Andrea Bocelli.

From 28 June
Hyde Park, SW 7



WWW.PRIDEINLONDON.ORG

PRIDE IN LONDON 2024

Pride in London celebrates LGBTQ+ London with revellers of all genders, sexualities, races and faiths. Following the array of events, the colourful Parade culminates in central London with free performances at Trafalgar Square.

Saturday 29 June
Across London / Trafalgar Square, WC2N 5DS



WWW.CANADADAY.LONDON

CANADA DAY

A great opportunity to enjoy all the things Canadian: live music, food together with retail. And to meet The Royal Canadian Mounted Police to take cool photos with.

30 June
Trafalgar Square, WC2N 5DS

EXHIBITIONS

May - June 2024



Unframed City: Paintings by Adrian Eckersley

1 to 25 May

Barbican Library, Barbican Centre, EC2Y 8DS

Paintings of the city mirrored in shards - its somewheres, its everywhere and its nowhere, remembered and forgotten. Don't miss an opportunity to see Adrian Eckersley's art, exhibited in Barbican Library. Depicting motorways, tunnels, transit hubs like alien spaces, the artist captures their true essence.

www.barbican.org.uk



Owen Harvey, United Kingdom. Sony World Photography Awards

Sony World Photography Awards

Until 6 May

Somerset House, Strand, WC2R 1LA

Sony World Photography Awards exhibition presents captivating narratives from across the globe, depicted through photography. See some truly extraordinary images – from luscious landscapes to impressive architecture, striking street shots to moving documentary projects.

www.somersetouse.org.uk



Photograph: Snowden

Royal Portraits: A Century of Photography

From 17 May

The King's Gallery, Buckingham Palace, SW1A 1AA

For centuries, portraiture has played a vital role in shaping the public's perception of the Royal Family. This major exhibition will chart the evolution of royal portrait photography over the past 100 years, through more than 150 works by the most celebrated royal photographers, from Dorothy Wilding to Annie Leibovitz.

www.rct.uk

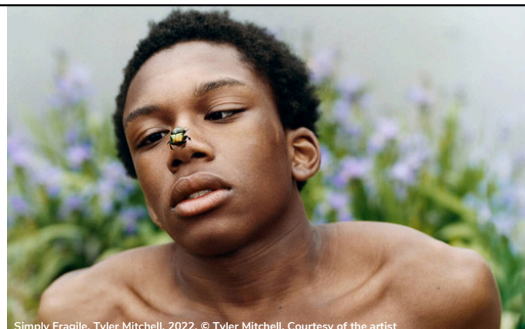

Simply Fragile, Tyler Mitchell, 2022. © Tyler Mitchell. Courtesy of the artist

Fragile Beauty

From 18 May

V&A South Kensington, Cromwell Road, SW7 2RL

Enjoy photographs from the Sir Elton John and David Furnish collection within an unparalleled selection of the world's leading photographers. Discover iconic images across subjects such as fashion, celebrity, reportage and the male body.

www.vam.ac.uk

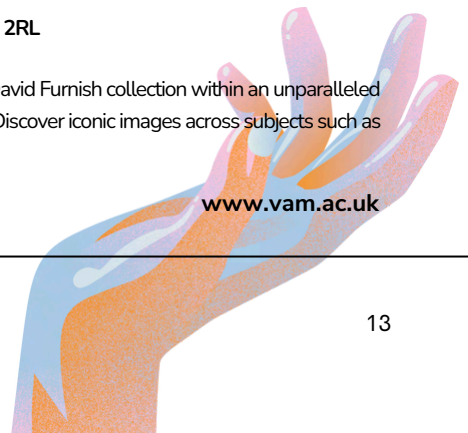



Image courtesy of Golden Tours

Princess Diana: Accredited Access Dockside Vaults, Ivory House, E1W 1AT

From 25 May

See behind-the scene life of The People's Princess at this intimate exhibition. There are 75 life-sized photographs that tell an untold story of how Princess Diana changed the world – through the lens of her official photographer.

www.princessdianaexhibit.com



Birds: Brilliant and Bizarre

From 25 May

Waterhouse Gallery, Natural History Museum, Cromwell Rd, SW7 5BD

It's time to get to know our feathered friends. You will be really surprised how beautiful and, well, weird, they are. Meet the oldest modern bird in the world, the so-called wonderchicken, find out what a pigeon has in common with a ferocious T. rex and discover how these winged wonders managed to survive the mass extinction that wiped out all of the other dinosaurs.

www.nhm.ac.uk



JR: Chronicles

From 4 June

Saatchi Gallery, King's Rd, SW3 4RY

Whether creating optical illusions at the Louvre or murals on top of maximum security prisons, artist JR's work is all about making a big impact. Saatchi Gallery features some of his most iconic projects from the past fifteen years.

Chronicles traces JR's career from his early documentation of graffiti artists as a teenager in Paris to his large-scale architectural interventions in cities worldwide and recent digitally collaged murals that create collective portraits of diverse communities.

www.saatchigallery.com

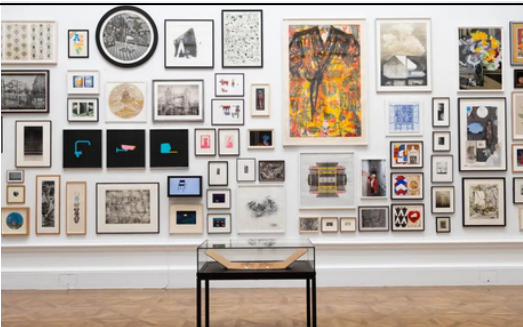

Summer Exhibition

From 13 June

The Royal Academy of Arts, Burlington House, Piccadilly, W1J 0BD

The Summer Exhibition is the world's oldest open submission exhibition – which means that anyone can enter their work to be considered for inclusion.

The works are selected and hung by Royal Academicians, who also exhibit their own works, creating an eclectic mix of work by established artists alongside emerging talent and first-time exhibitors.

www.royalacademy.org.uk



MAY — JUNE



THEATRES BILLBOARD

CABARET AT THE KIT KAT CLUB

- Until 2025
- Kit Kat Club at the Playhouse Theatre

Based on the classic Broadway musical, Cabaret tells the story of American writer Clifford Bradshaw and his relationship with British cabaret performer Sally Bowles, in 1930s Berlin. Spot Cara Delevingne in this musical is like no other.

www.kitkat.club

MEAN GIRLS

- From 5 June 2024
- Savoy Theatre

Hilarious hit musical from an award-winning creative team including writer Tina Fey comes to London in June. The famous plot is about surviving in the cruellest of jungles - High School.

www.thelyceumtheatre.com

STANDING AT THE SKY'S EDGE

- Until 3 August 2024
- Gillian Lynne Theatre

Winner of the Olivier Award and hailed as, "*The most exciting new British musical in years*" (WhatsOnStage). Standing at the Sky's Edge was originally written as a love letter to Sheffield, charting the hopes and dreams of three generations over the course of six tumultuous decades, navigating universal themes of love, loss and survival.

www.skysedgemusical.com

PLAYER KINGS

- Until 22 June 2024
- Noel Coward Theatre

Ian McKellen - "*One of the world's greatest actors*" (Times) - plays Falstaff in a new version of Shakespeare's Henry IV, adapted by the award-winning writer and director Robert Icke.

This play shows England as a divided country, with leadership crumbling and corruption in the air.

www.playerkingstheplay.co.uk

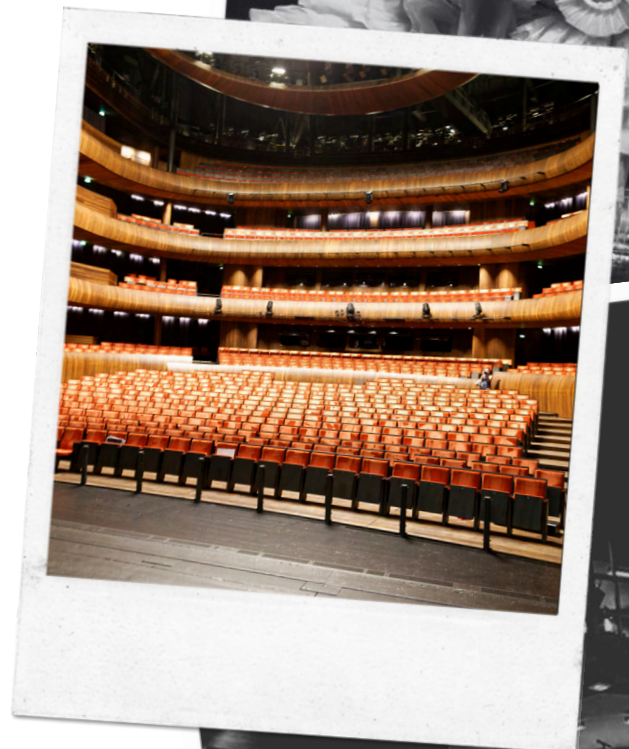

SPIRITED AWAY

- Until 24 August 2024
- London Coliseum

The original Japanese cast perform this extraordinary production with wildly imaginative puppets, dazzling set and costume designs and a live orchestra playing the magnificent original film score by Joe Hisaishi. The tale of Chihiro who while traveling to a new home with her family, stumbles into a world of fantastic spirits ruled over by the sorceress Yubaba.

www.spiritedawayuk.com

FAWLTY TOWERS

- 4 May to 28 September 2024
- Apollo Theatre

John Cleese's stage adaptation of his timeless '70s sitcom. There are also a few special interactive shows with the set in a restaurant where the audience are the diners.

www.thelyceumtheatre.com

GUYS & DOLLS

- 4 May to 28 September 2024
- The Bridge Theatre

The Bridge transforms for one of the greatest musicals of all time. It has more hit songs, more laughs and more romance than any show ever written. The immersive tickets transport you to the streets of Manhattan and the bars of Havana in the unlikelyst of love stories.

www.bridgetheatre.co.uk



REGENT'S PARK OPEN AIR THEATRE



- 23 March to 21 September, with the main performances in June and July
- Regent's Park, NW1 4DW

Sit in the stunning outdoor setting and enjoy enriching theatre that provides a lens to the here and now.

Nestled within the picturesque Queen Mary's Gardens, this outdoor venue boasts 1,300 seats against the enchanting backdrop of lush trees. The Regent's Park Open Theatre has already become an integral part of London's summer cultural scene.

Catch an exciting production of Twelfth Night, kid's favourite The Enormous Crocodile and a musical classic Fiddler on the Roof.

www.openairtheatre.com

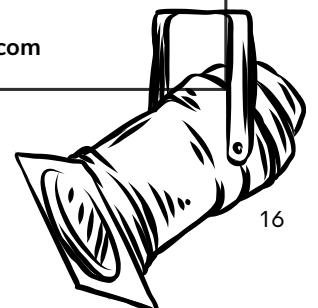

Family Events

IN MAY
AND JUNE

Perfect occasions await you to explore London with your kids. Choose from a vast array of family-friendly activities from London's top attractions to hotel stays; you won't be short of things to do with the family this season.





Celebrate International Harry Potter Day

On 2 May all Hogwarts enthusiasts should seize the occasion:

Head to the Warner Bros. Studio for a thematic tour, check Platform 9 ¾ at King's Cross station, and book Wizard's afternoon tea at Tower suites by Blue Orchid Hospitality.

Websites:

www.wbstudiotour.co.uk
www.blueorchid.com

Catch Disney100: The Exhibition at ExCel

The Walt Disney Archives has opened its vault of treasures, showcasing hundreds of extraordinary objects, including many of Disney's "Crown Jewels" – more than 250 rarely-seen artefacts and works of art, costumes and props, and incredible memorabilia.

Take a DLR from Tower Suites hotel or the Jubilee Line train from The Wellington hotel.

The exhibition closes on 21 June, so don't miss it.

Website:

www.disney100exhibit.com/london

See The Enormous Crocodile at Regent's Park Open Air Theatre

A new musical version of Roald Dahl's picture book in the open-air show promises to be incredible. The Enormous Crocodile is weaving his way through the jungle in search of delicious little fingers and squidgy podgy knees...

Tickets are available on dates between 17 May - 8 June.

Website: www.openairtheatre.com

Check the new Reptile House at London Zoo

Cold-blooded inhabitants are getting a new cool home. Admire mountain chicken frogs, big-headed turtles, panther chameleons and so much more.

Website: www.londonzoo.org

Spot life-like raptors at Dinosaur rEvolution

The exhibition in Horniman Museum, Forest Hill shows five giant animatronic models, dedicated to imagining what dinosaurs really looked like.

Website: www.horniman.ac.uk

Celebrate King Charles III's coronation anniversary

Tick off the capital's most memorable royal landmarks such as the Royal Mews and Westminster Abbey. In the warm season these gardens and attractions are especially enjoyable.

Visit The Paddington Bear Experience

Opening on 31 May, this immersive adventure with Paddington Bear and his friends will leave your kids not only entertained, but absolutely excited.

The tour begins at Paddington station and heads over to the Browns' house for the annual Marmalade Day festival.

Expect interactions, games, merch and, of course, marmalade eating opportunities.

Website: www.britmovietours.com

Get together for Father's Day

On 16 June you'll find plenty of opportunities to spend an unforgettable family holiday in London.

You can craft a perfect day by staying in The Wellington hotel by Blue Orchid Hospitality and visiting nearby dining and theatre spots.

Don't miss a last chance to join Roman Legion

The British Museum's impressive showcase, "Legion: Life in the Roman Army" offers an in-depth exploration into the daily experiences of soldiers across the Empire.

The exhibition concludes in June, so that's the last chance to see it during half-term holidays.

Website: www.britishmuseum.org

Visit Kensington Dollshouse Festival

The top craftsmen from around the globe who specialise in dolls houses, baby houses & miniatures gather together on 17 and 18 May.

Kids and adults alike will enjoy amazingly accurate dolls house mansions, tiny clothes pegs, small print fabrics, dolls furniture & accessories.

Book on Eventbrite.



20% off

at The Vegan Brasserie

Apply code CLA20 to
www.theveganbrasserie.com

Ts&Cs: Applies on food only. Not in conjunction with any other offer.
Subject to availability.

WHAT'S ON IN THE CITY OF LONDON

FROM CAPTIVATING NEW EXHIBITIONS TO WHISPERS OF THE CITY'S PAST, DISCOVER A TREASURE TROVE OF EXPERIENCES AND ENJOY AN UNFORGETTABLE DAY EXPLORING THE CITY OF LONDON.

The Future of Money

A new FREE exhibition at the Bank of England Museum.

Visit a brand-new exhibition at the Bank of England Museum responding directly to questions asked by the public about everything from the future of cash to future-proofing digital payment systems.

Explore the sustainability of money, learn about digital currencies, and think about the cultural impact money has. You'll also have chance to see the freshly-designed King Charles polymer banknotes (£5, £10, £20 and £50) before they officially enter circulation later in 2024.

Free, no need to book ahead, from **now until September 2025**.

Find out more:
www.bankofengland.co.uk/museum

THE FUTURE OF MONEY

Image courtesy of the Bank of England Museum



Credit: City of London Corporation / Rory Langdon



Credit: City of London Corporation / Rory Langdon

Let's Do Fridays in the City of London

Every Friday **until 31 May**, travel to the City for less with off-peak fares all day. Whether you're looking for somewhere new to lunch or socialise after work, a fun-filled afternoon with friends or a leisurely day out with family to keep the kids entertained, the City of London promises an array of experiences as the weekend kicks off.

Discover the City of London's guide to Fridays: www.thecityofldn.com/fridayinthecity



Credit: City of London Corporation

Anne Desmet, Kaleidoscope / London

Discover a fresh perspective on London, its architecture and geography at this new exhibition by artist and specialist wood engraver Anne Desmet RA.

Explore 150 artworks, including 41 London-themed prints created exclusively for this new exhibition. Delve deeper by joining one of the artist led exhibition tours.

On display **12 April – 8 September**
Admission: **Pay What You Can**
Opening times: **10 am - 5pm**

More details:
www.thecityofldn.com/kaleidoscope

City of London Corporation / Paul Clarke Photography



City of London Guided Tours

Join a walking tour of the City of London and discover historic sites and famous landmarks with an official City guide.

Join the popular City Highlights or try one of the themed tours including Romans, Wren's architecture, or the Great Fire of London. New guided walks from April include "Secrets and Symbols of the City", "From Shakespeare to Oscar Wilde" and "News from Fleet Street".

Tours take place daily and start from the City of London Information Centre. Booking is required.

Book now: www.thecityofldn.com/walks



Credit: City of London Corporation / Rory Langdon

Billingsgate Roman House and Baths Reopens for Public Tours

Discover one of Roman London's most fascinating remains with an official City Guide.

Preserved as if City archaeologists had just left the site and viewable from walkways a few metres off the ground, visitors can study the remains of the house and learn more about everyday Roman life.

Public tours are £12 (£10 child) and take place on Saturdays until November. Advance booking is required.

Find out more and book: www.thecityofldn.com/billingsgate



Credit: City of London Corporation

#londonloveaffair

Win Prizes from the London Love Affair Shop

Tag @ldnloveaffair_ on Instagram when posting your photos from London in May and June, make sure your following the account, for a chance to win a Hamper from the London Love Affair shop.

Competition closes on 30th June, 2024, one winner will be selected at random.



CENTO
ALLA TORRE

Free Dessert

Treat yourself to a complimentary dessert with the purchase of any large plate or pizza. to redeem, present this voucher when ordering.

Ts &Cs: Cannot be used in conjunction with any other offer. Cannot be exchanged for cash value. Valid until 30th June, 2024. Subject to availability.



GIVE THE GIFT OF LONDON WITH THE CITY GIFT CARD



CITYGIFTCARD.LONDON



CELEBRATE SUMMER

WITH BLUE ORCHID HOSPITALITY



ENQUIRE TODAY



BLUE ORCHID
HOSPITALITY

events@blueorchid.com

0203 972 1800

www.blueorchid.com

WIN

A COMPLIMENTARY
STAY

SCAN TO
ENTER



#londonloveaffair

Brought to you by

CENTRAL LONDON ALLIANCE

In partnership with

**BLUE ORCHID
HOSPITALITY**

www.blueorchid.com

OPTIMISER

www.optimiser.com



THIS IS WHERE
...we'd make new memories



hello@centrallondonalliance.com

www.centrallondonalliance.com